



Newport Series.

LINEAGE
COLLECTION

A&L
WINDOWS | DOORS
A JELD-WEN Company

Newport Series.

Casual elegance, muted tones

Originally inspired by the affluent coastal villages of New York’s Long Island, the Newport series offers the casual sophistication epitomized by the ‘Hamptons style’. With a segmented grid tastefully overlaid on the top section of the pane (available in a single or double row), Newport offers an unobstructed view through the majority of the glass. It lets natural light in and captures the spacious ambience of life on the coast—even in the heart of the city.

Newport’s tastefully minimalist style is suited to neutral palettes of soothing grey, navy and duck-egg blue, and can be beautifully offset by warm bursts of timber. It’s classic, casual and effortlessly elegant, and is best paired with similarly timeless pieces, rather than cutting edge modern design elements. Stick with a pared-back aesthetic and bring the relaxed coastal atmosphere of holidays into the home.

Please Note

Horizontal bars are applied at a set distance from the top of the window, regardless of the sash type, to ensure bar alignment across a whole product. We recommend selecting all Wideline Sashes to achieve the best look.

Please consider other nearby products, as they may need to be customised if you wish for all bars to align. Standard bar positioning on doors differs from windows to allow for the thicker aluminium sections, which take up more of the glass area.

Please discuss your specification with an A&L sales representative to ensure your desired aesthetic can be achieved.



Newport Series - Single



Newport Series - Double

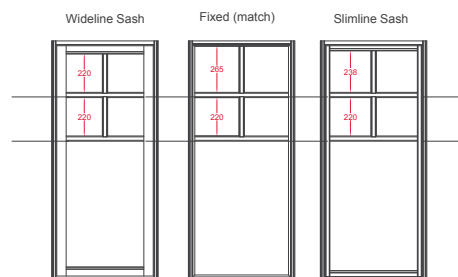



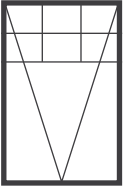
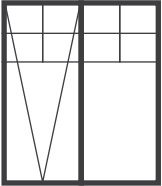
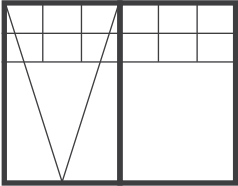
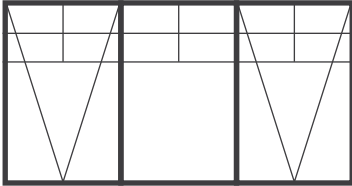

Illustration of a 1372mm high awning window.

Boutique & Standard Awning Windows

Lineage Collection - Newport Series

Code Prefix: WAAW Colonial Bar Pattern: Newport

Double

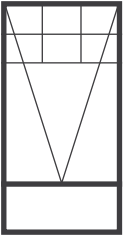
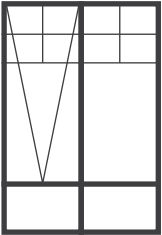
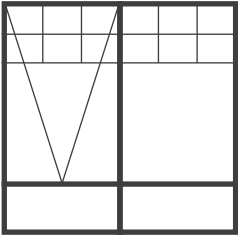
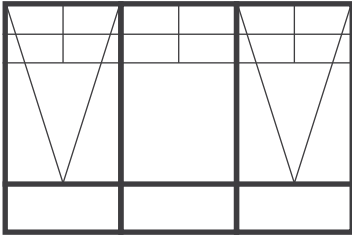
Size Code		03	06	09	12	15	18	21	24	27
O/A Reveal Size (mm)		330 (Fixed Only)	610	850	1210	1450	1810	2170	2398	2704
10	1027									
12	1200									
14	1372									
15	1543									
18	1800									
20	2057									
23	2315									

Please Note: Visible glass area between bars can vary in size across the same product, depending on product type, size and configuration. Speak to your A&L sales representative to find out more.

 Custom size, available upon request

Please Note: Size charts are provided as a guide only, images are viewed externally and refer to A&L's standard offering for N2 areas. Specific size limitations or alternative options may be applicable for other wind categories or account customer specific ranges. The A&L website Terms of Use apply to this document.

Boutique & Standard Awning Windows

Lineage Collection - Newport Series

Code Prefix: WAAW Colonial Bar Pattern: Newport

Single

Size Code		03	06	09	12	15	18	21	24	27
O/A Reveal Size (mm)		330 (Fixed Only)	610	850	1210	1450	1810	2170	2398	2704
09	854									
10	1027									
12	1200									
14	1372									
15	1543									
18	1800									
20	2057									
23	2315									

Please Note: Visible glass area between bars can vary in size across the same product, depending on product type, size and configuration. Speak to your A&L sales representative to find out more.

Please Note: Size charts are provided as a guide only, images are viewed externally and refer to A&L's standard offering for N2 areas. Specific size limitations or alternative options may be applicable for other wind categories or account customer specific ranges. The A&L website Terms of Use apply to this document.

Boutique Armadale Awning Windows

Lineage Collection - Newport Series

Code Prefix: WAAW Colonial Bar Pattern: Newport

Double

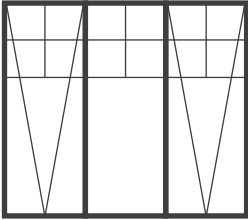
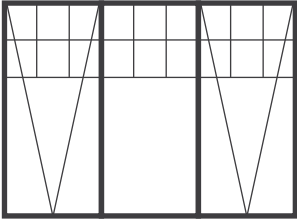
Size Code		18	21	24	27	30	36	
	O/A Reveal Size (mm)	1810	2170	2410	2710	3010	3610	
18	1800							
20	2057							
23	2315							

Single

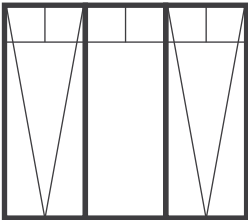
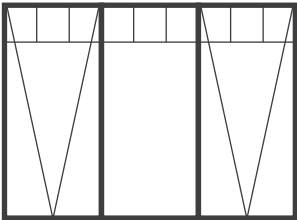
Size Code		18	21	24	27	30	36	
	O/A Reveal Size (mm)	1810	2170	2410	2710	3010	3610	
18	1800							
20	2057							
23	2315							

Please Note: Visible glass area between bars can vary in size across the same product, depending on product type, size and configuration. Speak to your A&L sales representative to find out more.

Please Note: Size charts are provided as a guide only, images are viewed externally and refer to A&L's standard offering for N2 areas. Specific size limitations or alternative options may be applicable for other wind categories or account customer specific ranges. The A&L website Terms of Use apply to this document.

Standard Armadale Awning Windows

Lineage Collection - Newport Series

Code Prefix: WAAW Colonial Bar Pattern: Newport

Double

Size Code		03	06	09	12	15	18	21	24	27
	O/A Reveal Size (mm)	330 (Fixed Only)	610	850	1210	1450	1810	2170	2398	2704
18	1800									
20	2057									
23	2315									

Single

Size Code		03	06	09	12	15	18	21	24	27
	O/A Reveal Size (mm)	330 (Fixed Only)	610	850	1210	1450	1810	2170	2398	2704
18	1800									
20	2057									
23	2315									

Please Note: Visible glass area between bars can vary in size across the same product, depending on product type, size and configuration. Speak to your A&L sales representative to find out more.





Please Note: Size charts are provided as a guide only, images are viewed externally and refer to A&L's standard offering for N2 areas. Specific size limitations or alternative options may be applicable for other wind categories or account customer specific ranges. The A&L website Terms of Use apply to this document.

Boutique Georgian Awning Windows



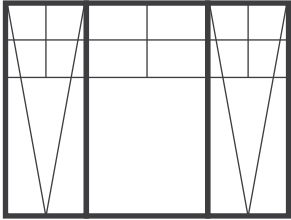
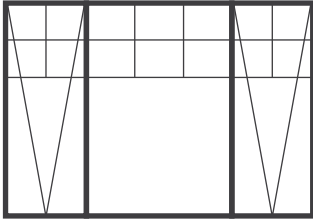
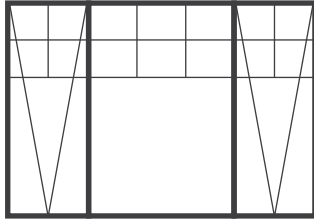
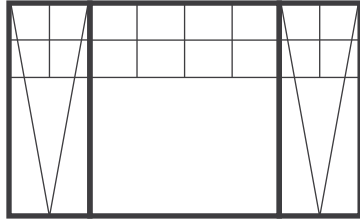
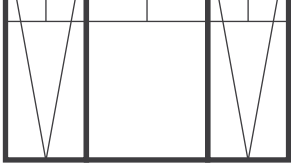
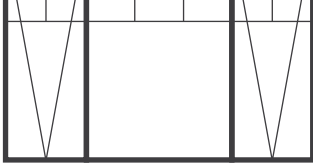
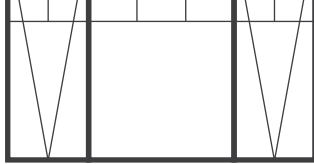
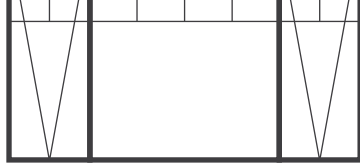



Lineage Collection - Newport Series

Code Prefix: WAAW Colonial Bar Pattern: Newport

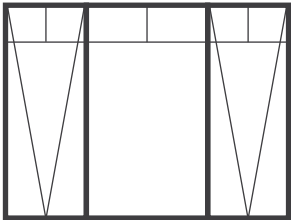
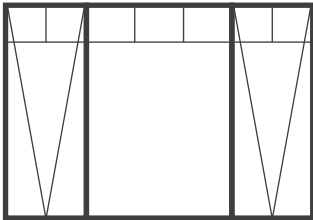
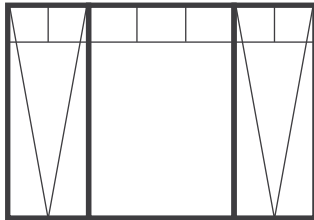
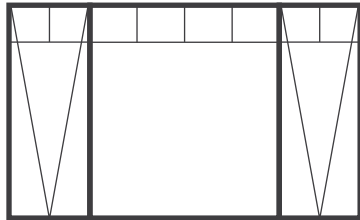
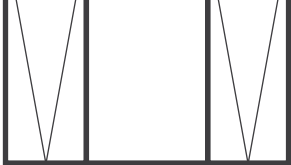
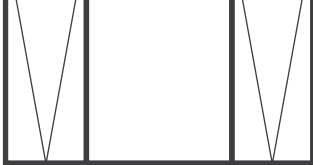
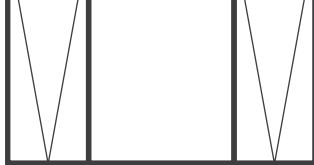
Double

Size Code		18	21	24	27	30	36
	O/A Reveal Size (mm)	1800	2170	2410	2710	3010	3610
18	1800						
20	2057						
23	2315						

Single

Size Code		18	21	24	27	30	36
	O/A Reveal Size (mm)	1800	2170	2410	2710	3010	3610
18	1800						
20	2057						
23	2315						

Please Note: Visible glass area between bars can vary in size across the same product, depending on product type, size and configuration. Speak to your A&L sales representative to find out more.

Please Note: Size charts are provided as a guide only, images are viewed externally and refer to A&L's standard offering for N2 areas. Specific size limitations or alternative options may be applicable for other wind categories or account customer specific ranges. The A&L website Terms of Use apply to this document.

Standard Georgian Awning Windows

Lineage Collection - Newport Series

Code Prefix: WAAW Colonial Bar Pattern: Newport

Double

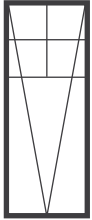
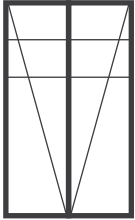
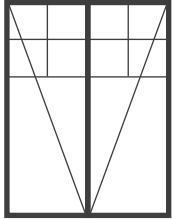
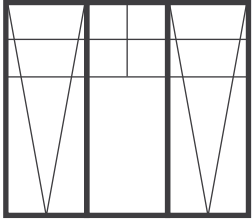
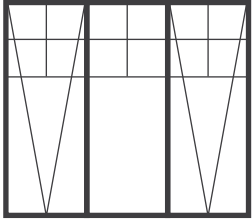
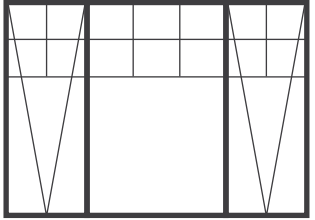
Size Code		06	09	12	15	18	21	24
	O/A Reveal Size (mm)	610	850	1210	1450	1810	2170	2398
10	1027							
12	1200							
14	1372							
15	1543							
18	1800							
20	2057							
23	2315							

Please Note: Visible glass area between bars can vary in size across the same product, depending on product type, size and configuration. Speak to your A&L sales representative to find out more.

 Custom size, available upon request

Please Note: Size charts are provided as a guide only, images are viewed externally and refer to A&L's standard offering for N2 areas. Specific size limitations or alternative options may be applicable for other wind categories or account customer specific ranges. The A&L website Terms of Use apply to this document.

Standard Georgian Awning Windows

Lineage Collection - Newport Series

Code Prefix: WAAW Colonial Bar Pattern: Newport

Single

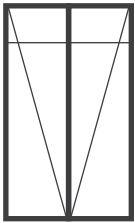
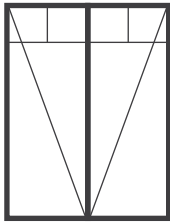
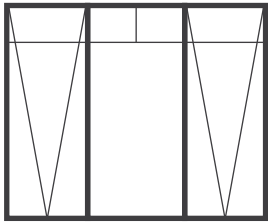
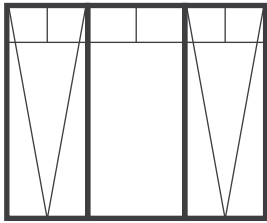
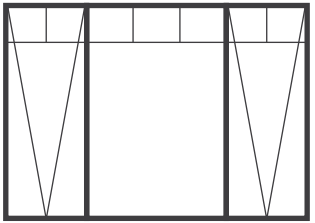
Size Code		06	09	12	15	18	21	24
	O/A Reveal Size (mm)	610	850	1210	1450	1810	2170	2398
09	854							
10	1027							
12	1200							
14	1372							
15	1543							
18	1800							
20	2057							
23	2315							

Please Note: Visible glass area between bars can vary in size across the same product, depending on product type, size and configuration. Speak to your A&L sales representative to find out more.

 Custom size, available upon request

Please Note: Size charts are provided as a guide only, images are viewed externally and refer to A&L's standard offering for N2 areas. Specific size limitations or alternative options may be applicable for other wind categories or account customer specific ranges. The A&L website Terms of Use apply to this document.

Boutique Fixed No Mullion Windows

Lineage Collection – Newport Series

Code Prefix: WAAW Colonial Bar Pattern: Newport

Double

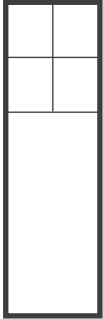
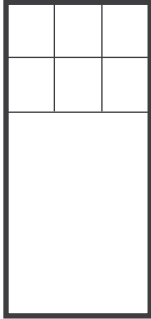
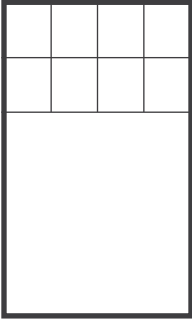
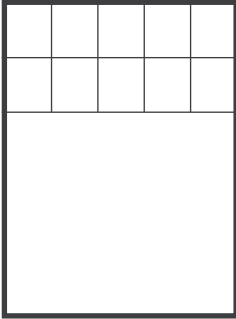
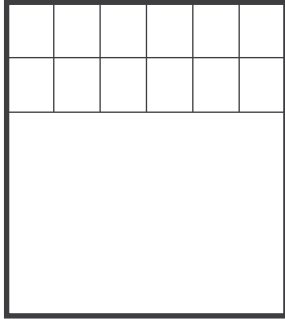
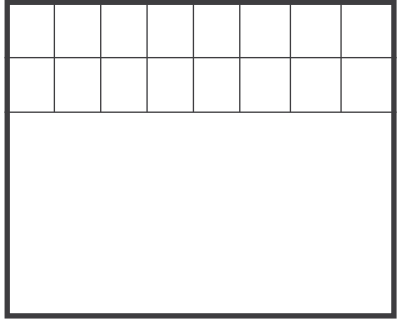
Size Code		06	09	12	15	18	21	24	27	30	36
	O/A Reveal Size (mm)	610	850	1210	1450	1810	2170	2398	2704	3010	3610
10	1027										
12	1200										
14	1372										
15	1543										
18	1800										
20	2057										
23	2315										

Please Note: Visible glass area between bars can vary in size across the same product, depending on product type, size and configuration. Speak to your A&L sales representative to find out more.

 Custom size, available upon request



Please Note: Size charts are provided as a guide only, images are viewed externally and refer to A&L's standard offering for N2 areas. Specific size limitations or alternative options may be applicable for other wind categories or account customer specific ranges. The A&L website Terms of Use apply to this document.

Boutique Fixed No Mullion Windows

Lineage Collection – Newport Series

Code Prefix: WAAW Colonial Bar Pattern: Newport

Single

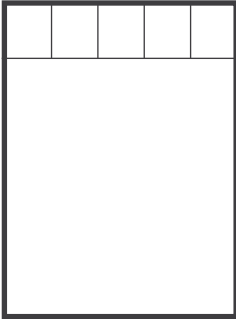
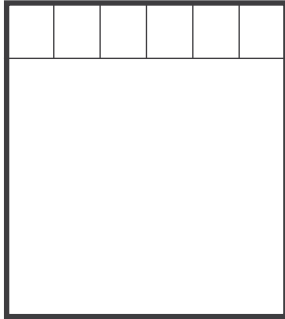
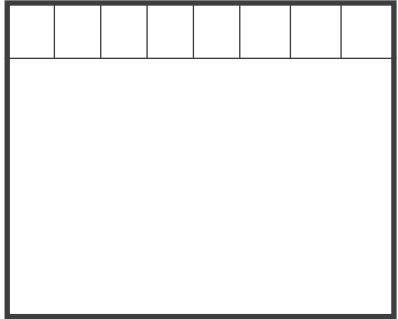
Size Code		06	09	12	15	18	21	24	27	30	36
	O/A Reveal Size (mm)	610	850	1210	1450	1810	2170	2398	2704	3010	3610
09	854										
10	1027										
12	1200										
14	1372										
15	1543										
18	1800										
20	2057										
23	2315										

Please Note: Visible glass area between bars can vary in size across the same product, depending on product type, size and configuration. Speak to your A&L sales representative to find out more.

 Custom size, available upon request

Please Note: Size charts are provided as a guide only, images are viewed externally and refer to A&L's standard offering for N2 areas. Specific size limitations or alternative options may be applicable for other wind categories or account customer specific ranges. The A&L website Terms of Use apply to this document.

Boutique Fixed One Mullion Windows

Lineage Collection – Newport Series

Code Prefix: WAAW Colonial Bar Pattern: Newport

Double

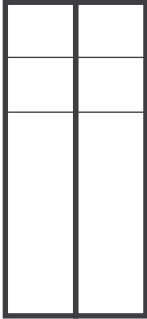
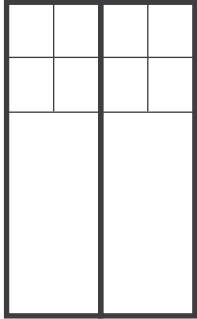
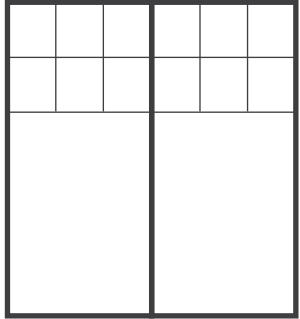
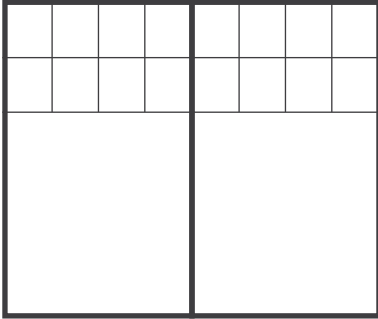
Size Code		06	09	12	15	18	21	24	27	30	36
	O/A Reveal Size (mm)	610	850	1210	1450	1810	2170	2398	2704	3010	3610
10	1027										
12	1200										
14	1372										
15	1543										
18	1800										
20	2057										
23	2315										

Please Note: Visible glass area between bars can vary in size across the same product, depending on product type, size and configuration. We recommend sashes in lieu of any fixed lites for the most consistent aesthetic. Speak to your A&L sales representative to find out more.

 Custom size, available upon request

Please Note: Size charts are provided as a guide only, images are viewed externally and refer to A&L's standard offering for N2 areas. Specific size limitations or alternative options may be applicable for other wind categories or account customer specific ranges. The A&L website Terms of Use apply to this document.

Boutique Fixed One Mullion Windows

Lineage Collection – Newport Series

Code Prefix: WAAW Colonial Bar Pattern: Newport

Single

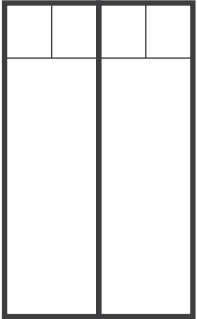
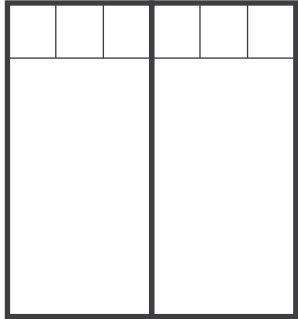
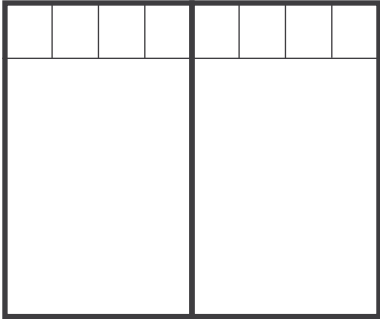
Size Code		06	09	12	15	18	21	24	27	30	36
	O/A Reveal Size (mm)	610	850	1210	1450	1810	2170	2398	2704	3010	3610
09	854										
10	1027										
12	1200										
14	1372										
15	1543										
18	1800										
20	2057										
23	2315										

Please Note: Visible glass area between bars can vary in size across the same product, depending on product type, size and configuration. We recommend sashes in lieu of any fixed lites for the most consistent aesthetic. Speak to your A&L sales representative to find out more.

 Custom size, available upon request

Please Note: Size charts are provided as a guide only, images are viewed externally and refer to A&L's standard offering for N2 areas. Specific size limitations or alternative options may be applicable for other wind categories or account customer specific ranges. The A&L website Terms of Use apply to this document.

Boutique Fixed Two Mullion Windows

Lineage Collection – Newport Series

Code Prefix: WAAW Colonial Bar Pattern: Newport

Double

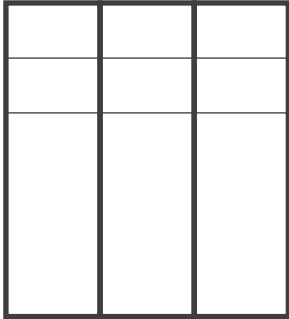
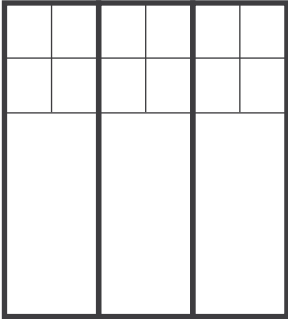
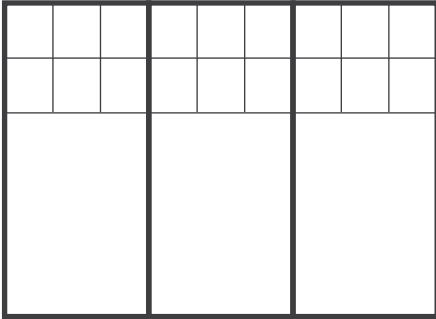
Size Code		12	15	18	21	24	27	30	36	
	O/A Reveal Size (mm)	1210	1450	1810	2170	2398	2704	3010	3610	
10	1027									
12	1200									
14	1372									
15	1543									
18	1800									
20	2057									
23	2315									

Please Note: Visible glass area between bars can vary in size across the same product, depending on product type, size and configuration. We recommend sashes in lieu of any fixed lites for the most consistent aesthetic. Speak to your A&L sales representative to find out more.

 Custom size, available upon request

Please Note: Size charts are provided as a guide only, images are viewed externally and refer to A&L's standard offering for N2 areas. Specific size limitations or alternative options may be applicable for other wind categories or account customer specific ranges. The A&L website Terms of Use apply to this document.

Boutique Fixed Two Mullion Windows

Lineage Collection – Newport Series

Code Prefix: WAAW Colonial Bar Pattern: Newport

Single

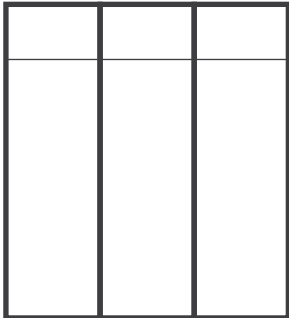
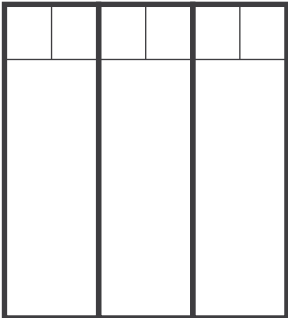
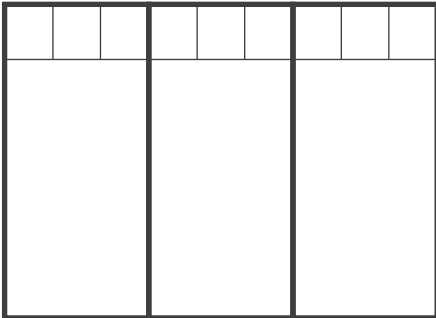
Size Code		12	15	18	21	24	27	30	36	
	O/A Reveal Size (mm)	1210	1450	1810	2170	2398	2704	3010	3610	
09	854									
10	1027									
12	1200									
14	1372									
15	1543									
18	1800									
20	2057									
23	2315									

Please Note: Visible glass area between bars can vary in size across the same product, depending on product type, size and configuration. We recommend sashes in lieu of any fixed lites for the most consistent aesthetic. Speak to your A&L sales representative to find out more.

 Custom size, available upon request

Please Note: Size charts are provided as a guide only, images are viewed externally and refer to A&L's standard offering for N2 areas. Specific size limitations or alternative options may be applicable for other wind categories or account customer specific ranges. The A&L website Terms of Use apply to this document.

Boutique Fixed Three Mullion Windows

Lineage Collection – Newport Series

Code Prefix: WAAW Colonial Bar Pattern: Newport

Double

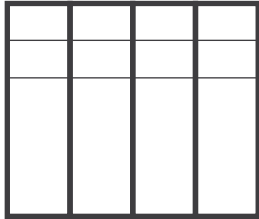
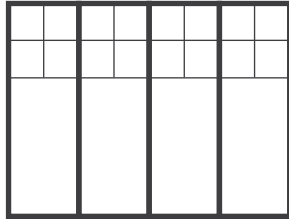
Size Code		18	21	24	27	30	36
	O/A Reveal Size (mm)	1810	2170	2398	2704	3010	3610
10	1027						
12	1200						
14	1372						
15	1543						
18	1800						
20	2057						
23	2315						

Please Note: Visible glass area between bars can vary in size across the same product, depending on product type, size and configuration. We recommend sashes in lieu of any fixed lites for the most consistent aesthetic. Speak to your A&L sales representative to find out more.

 Custom size, available upon request

Please Note: Size charts are provided as a guide only, images are viewed externally and refer to A&L's standard offering for N2 areas. Specific size limitations or alternative options may be applicable for other wind categories or account customer specific ranges. The A&L website Terms of Use apply to this document.

Boutique Fixed Three Mullion Windows

Lineage Collection – Newport Series

Code Prefix: WAAW Colonial Bar Pattern: Newport

Single

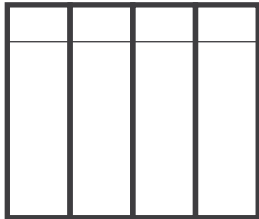
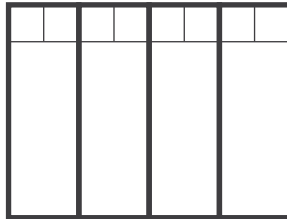
Size Code		18	21	24	27	30	36
	O/A Reveal Size (mm)	1810	2170	2398	2704	3010	3610
09	854						
10	1027						
12	1200						
14	1372						
15	1543						
18	1800						
20	2057						
23	2315						

Please Note: Visible glass area between bars can vary in size across the same product, depending on product type, size and configuration. We recommend sashes in lieu of any fixed lites for the most consistent aesthetic. Speak to your A&L sales representative to find out more.

 Custom size, available upon request

Please Note: Size charts are provided as a guide only, images are viewed externally and refer to A&L's standard offering for N2 areas. Specific size limitations or alternative options may be applicable for other wind categories or account customer specific ranges. The A&L website Terms of Use apply to this document.

Sliding Windows

Lineage Collection - Newport Series

Code Prefix: WASL Colonial Bar Pattern: Newport

Double

Size Code		03	06	09	12	15	18	21	24	27
O/A Reveal Size (mm)		330 (Fixed Only)	610	850	1210	1450	1810	2170	2398	2704
10	1027									
12	1200									
14	1372									
15	1543									
18	1800									
20	2057									
23	2315									

Please Note: Visible glass area between bars can vary in size across the same product, depending on product type, size and configuration. We recommend sashes in lieu of any fixed lites for the most consistent aesthetic. Speak to your A&L sales representative to find out more.

Custom size, available upon request

Please Note: Size charts are provided as a guide only, images are viewed externally and refer to A&L's standard offering for N2 areas. Specific size limitations or alternative options may be applicable for other wind categories or account customer specific ranges. The A&L website Terms of Use apply to this document.

Sliding Windows

Lineage Collection - Newport Series

Code Prefix: WASL Colonial Bar Pattern: Newport

Single

Size Code		03	06	09	12	15	18	21	24	27
O/A Reveal Size (mm)		330 (Fixed Only)	610	850	1210	1450	1810	2170	2398	2704
09	854									
10	1027									
12	1200									
14	1372									
15	1543									
18	1800									
20	2057									
23	2315									

Please Note: Visible glass area between bars can vary in size across the same product, depending on product type, size and configuration. We recommend sashes in lieu of any fixed lites for the most consistent aesthetic. Speak to your A&L sales representative to find out more.

 Custom size, available upon request

Please Note: Size charts are provided as a guide only, images are viewed externally and refer to A&L's standard offering for N2 areas. Specific size limitations or alternative options may be applicable for other wind categories or account customer specific ranges. The A&L website Terms of Use apply to this document.

Standard Sliding Doors

Lineage Collection – Newport Series

Code Prefix: DASL Colonial Bar Pattern: Newport

Double

Size Code		14	18	21	24	27	30	32	36
	O/A Reveal Size (mm)	1450	1810	2170	2410	2690	3010	3230	3590
21	2110								
23	2370								

Single

Size Code		14	18	21	24	27	30	32	36
	O/A Reveal Size (mm)	1450	1810	2170	2410	2690	3010	3230	3590
21	2110								
23	2370								

Please Note: Visible glass area between bars can vary in size across the same product, depending on product type, size and configuration. Speak to your A&L sales representative to find out more.

Please Note: Size charts are provided as a guide only, images are viewed externally and refer to A&L's standard offering for N2 areas. Specific size limitations or alternative options may be applicable for other wind categories or account customer specific ranges. The A&L website Terms of Use apply to this document.

Standard Sliding Doors

Lineage Collection – Newport Series

Code Prefix: DASL Colonial Bar Pattern: Newport

Bi-Parting Double

Size Code		28	36	42	48
	O/A Reveal Size (mm)	2855	3590	4295	4775
21	2110				
23	2370				

Bi-Parting Single

Size Code		28	36	42	48
	O/A Reveal Size (mm)	2855	3590	4295	4775
21	2110				
23	2370				

Please Note: Visible glass area between bars can vary in size across the same product, depending on product type, size and configuration. Speak to your A&L sales representative to find out more.

Please Note: Size charts are provided as a guide only, images are viewed externally and refer to A&L's standard offering for N2 areas. Specific size limitations or alternative options may be applicable for other wind categories or account customer specific ranges. The A&L website Terms of Use apply to this document.

Standard Sliding Doors

Lineage Collection – Newport Series

Code Prefix: DASL Colonial Bar Pattern: Newport

Entertainer Double

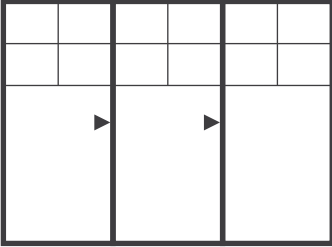
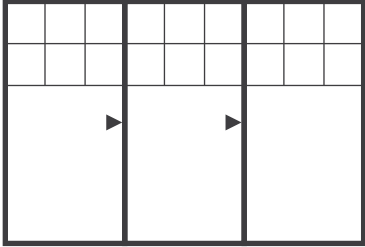
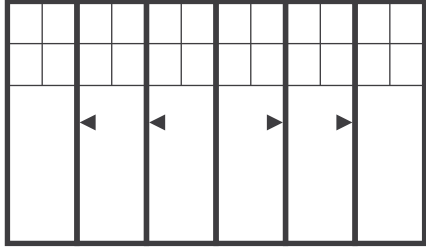
Size Code		21	27	32	36	42
	O/A Reveal Size (mm)	2133	2673	3231	3573	4217
21	2110					
23	2370					

Entertainer Single

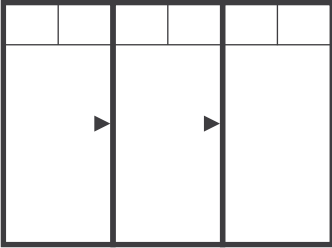
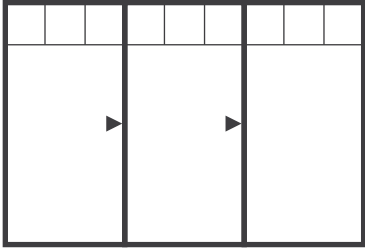
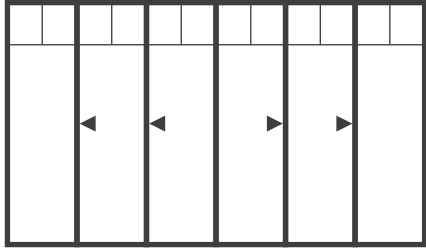
Size Code		21	27	32	36	42
	O/A Reveal Size (mm)	2133	2673	3231	3573	4217
21	2110					
23	2370					

Please Note: Visible glass area between bars can vary in size across the same product, depending on product type, size and configuration. Speak to your A&L sales representative to find out more.

Please Note: Size charts are provided as a guide only, images are viewed externally and refer to A&L's standard offering for N2 areas. Specific size limitations or alternative options may be applicable for other wind categories or account customer specific ranges. The A&L website Terms of Use apply to this document.

Boutique Sliding Doors

Lineage Collection – Newport Series

Code Prefix: DASL Colonial Bar Pattern: Newport

Double

Size Code		14	18	21	24	27		32	36
	O/A Reveal Size (mm)	1450	1810	2170	2410	2690		3230	3590
21	2110								
23	2370								
26	2660								

Single

Size Code		14	18	21	24	27		32	36
	O/A Reveal Size (mm)	1450	1810	2170	2410	2690		3230	3590
21	2110								
23	2370								
26	2660								

Please Note: Visible glass area between bars can vary in size across the same product, depending on product type, size and configuration. Speak to your A&L sales representative to find out more.

Please Note: Size charts are provided as a guide only, images are viewed externally and refer to A&L's standard offering for N2 areas. Specific size limitations or alternative options may be applicable for other wind categories or account customer specific ranges. The A&L website Terms of Use apply to this document.

Boutique Sliding Doors

Lineage Collection – Newport Series

Code Prefix: DASL Colonial Bar Pattern: Newport

Bi-Parting Double

Size Code		28	36	42	48	53	59
	O/A Reveal Size (mm)	2824	3544	4264	4744	5344	5944
21	2110						
23	2370						
26	2660						

Bi-Parting Single

Size Code		28	36	42	48	53	59
	O/A Reveal Size (mm)	2824	3544	4264	4744	5344	5944
21	2110						
23	2370						
26	2660						

Please Note: Visible glass area between bars can vary in size across the same product, depending on product type, size and configuration. Speak to your A&L sales representative to find out more.

Please Note: Size charts are provided as a guide only, images are viewed externally and refer to A&L's standard offering for N2 areas. Specific size limitations or alternative options may be applicable for other wind categories or account customer specific ranges. The A&L website Terms of Use apply to this document.

Boutique Sliding Doors

Lineage Collection – Newport Series

Code Prefix: DASL Colonial Bar Pattern: Newport

Entertainer Double

Size Code		21	27	30	32	36	48	54	42	53	64
	O/A Reveal Size (mm)	2133	2673	2994	3213	3573	4833	5373	4188	5268	6368
21	2110										
23	2370										
26	2660										

Entertainer Single

Size Code		21	27	30	32	36	48	54	42	53	64
	O/A Reveal Size (mm)	2133	2673	2994	3213	3573	4833	5373	4188	5268	6368
21	2110										
23	2370										
26	2660										

Please Note: Visible glass area between bars can vary in size across the same product, depending on product type, size and configuration. Speak to your A&L sales representative to find out more.

Please Note: Size charts are provided as a guide only, images are viewed externally and refer to A&L's standard offering for N2 areas. Specific size limitations or alternative options may be applicable for other wind categories or account customer specific ranges. The A&L website Terms of Use apply to this document.

Boutique French Doors

Lineage Collection – Newport Series

Code Prefix: DAFR Colonial Bar Pattern: Newport

Double

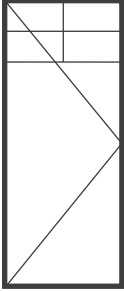
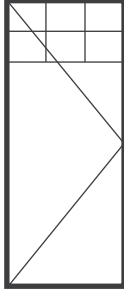
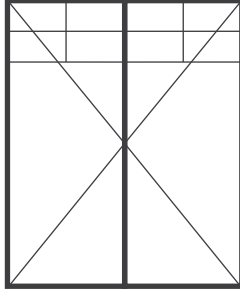
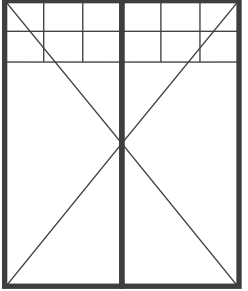
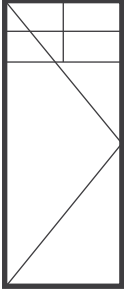
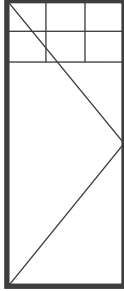
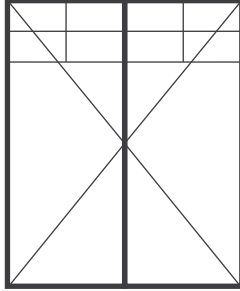
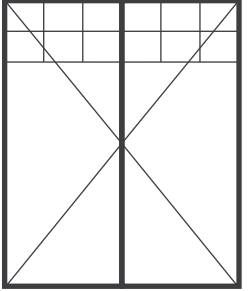
Size Code		06	08	09	10	11	12	15	17	19	21
	O/A Reveal Size (mm)	648	768	898	1013	1113	1210	1450	1710	1940	2140
21	2110										
23	2370										

Single

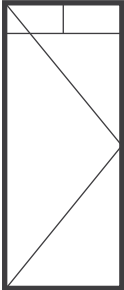
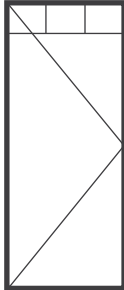
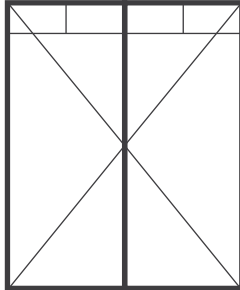
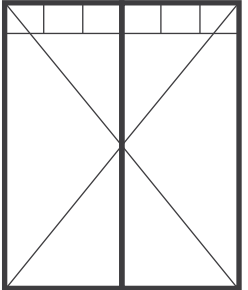
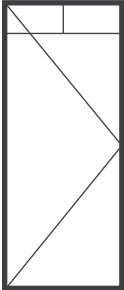
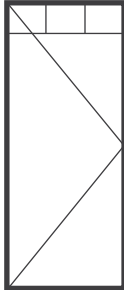
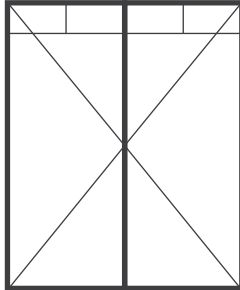
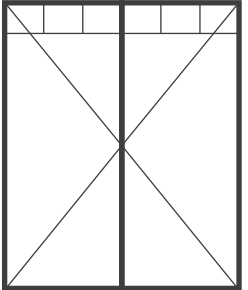
Size Code		06	08	09	10	11	12	15	17	19	21
	O/A Reveal Size (mm)	648	768	898	1013	1113	1210	1450	1710	1940	2140
21	2110										
23	2370										

Please Note: Visible glass area between bars can vary in size across the same product, depending on product type, size and configuration. Speak to your A&L sales representative to find out more.

Please Note: Size charts are provided as a guide only, images are viewed externally and refer to A&L's standard offering for N2 areas. Specific size limitations or alternative options may be applicable for other wind categories or account customer specific ranges. The A&L website Terms of Use apply to this document.